

UNIJET 500

7.5 kW; 9 kW; 11 kW; 12.5 kW (50Hz)
8.6 kW; 10.4 kW; 12.6 kW; 14.5 kW (60Hz)

Per l'aspirazione di fluidi diversi dall'aria non contaminata o a temperature superiori ai 40°C vi preghiamo di contattarci.

The standard side channel blowers/aspirators are designed to handle clean air up to a maximum of 40°C. Please contact us for special applications.

Motori costruiti secondo le norme CEI 2-3 (1988) ISOL. CL F PROT. IP 55 e certificati cCSAus

Motors construction conform with CEI 2-3 (1988) NORMS. ISOL. CL F PROT. IP 55, cCSAus certified

cCSAus file nr. 242079 

	Articolo Item code	kW	V	Hz	assorb. AMP absorbed AMPS	giri/min. r.p.m.	limite servizio max cont. duty S1 (mbar)	dB (A)*	peso (Kg) weight (Kg)
TRIFASE THREE-PHASE	080006	7.5	345-415 Δ	50	17.8	2900	-295 +285	78	96
	080006	8.6	380-480 Δ	60	17.7	3500	-225 +205	84	96
	080049	9	345-415 Δ	50	22.3	2900	-315 +320	78	102
	080049	10.4	380-480 Δ	60	20.4	3500	-315 +285	84	102
	080076	11	345-415 Δ	50	24.2	2900	-390 +400	78	112
	080076	12.6	380-480 Δ	60	24.8	3500	-370 +345	84	112
	080074	12.5	345-415 Δ	50	26.8	2900	-390 +465	78	112
	080074	14.5	380-480 Δ	60	28.0	3500	-400 +390	84	112

* Livello di pressione sonora rilevato secondo le Norme ISO 3746 - 1979 (E). Parametri: r=1 - Rumore di fondo 51 dB (A) - Strumento: Brüel & Kjær type 2232.

* Sound pressure level tested according to ISO regulation 3746 - 1979 (E). Parameters: r=1 - Background noise 51 dB (A) - Instrument: Brüel & Kjær type 2232.

**dimensioni:
dimensions:**

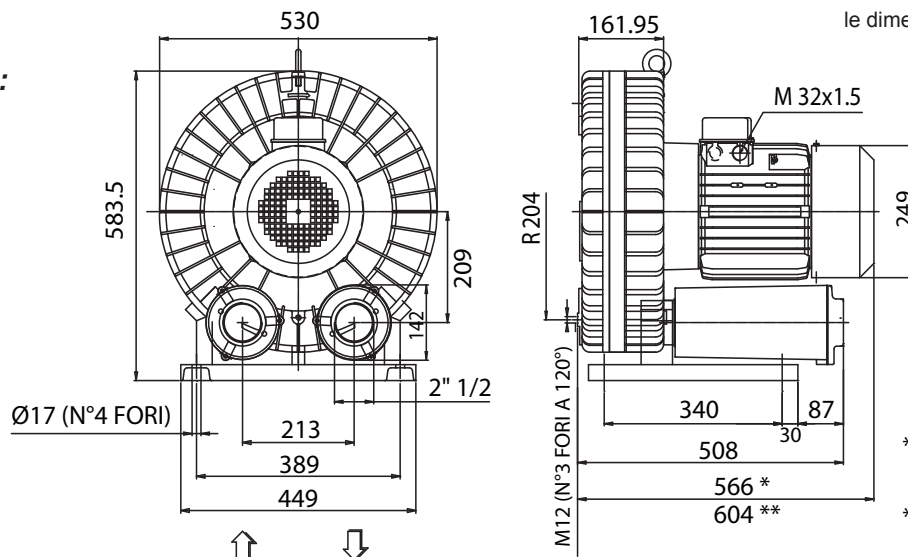

le dimensioni sono espresse in millimetri
all dimensions are in mm

* 7.5; 9 kW (50Hz) and
8.6; 10.4 (60Hz) models
** 11; 12.5 (50Hz) and
12.6; 14.5 (60Hz) models

ASPIRAZIONE VACUUM

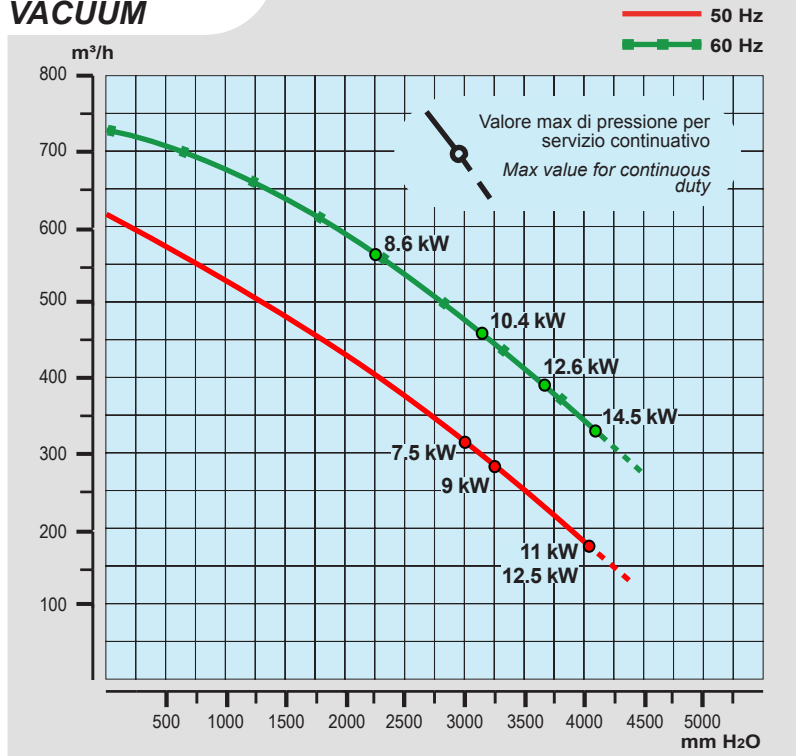

ASSORBIMENTO MOTORE MOTOR ABSORPTION

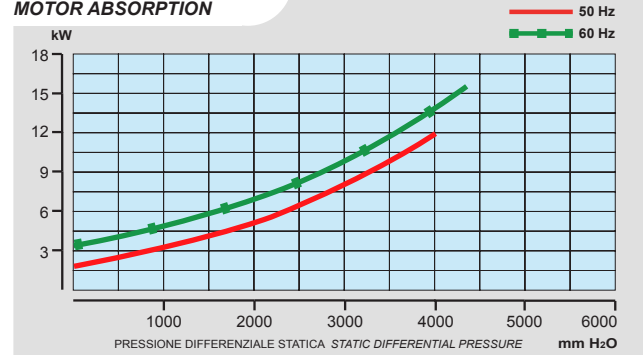

INCREMENTO TEMPERATURA ARIA AIR TEMPERATURE INCREASE

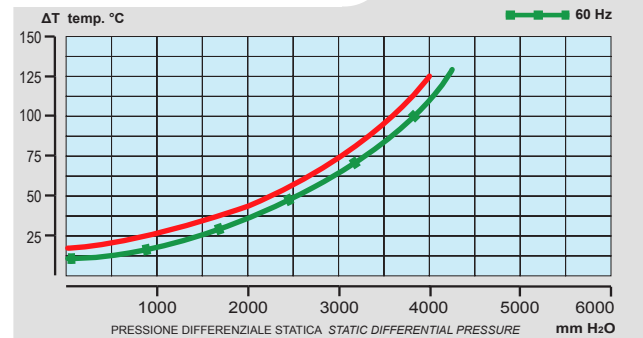

COMPRESSIONE PRESSURE

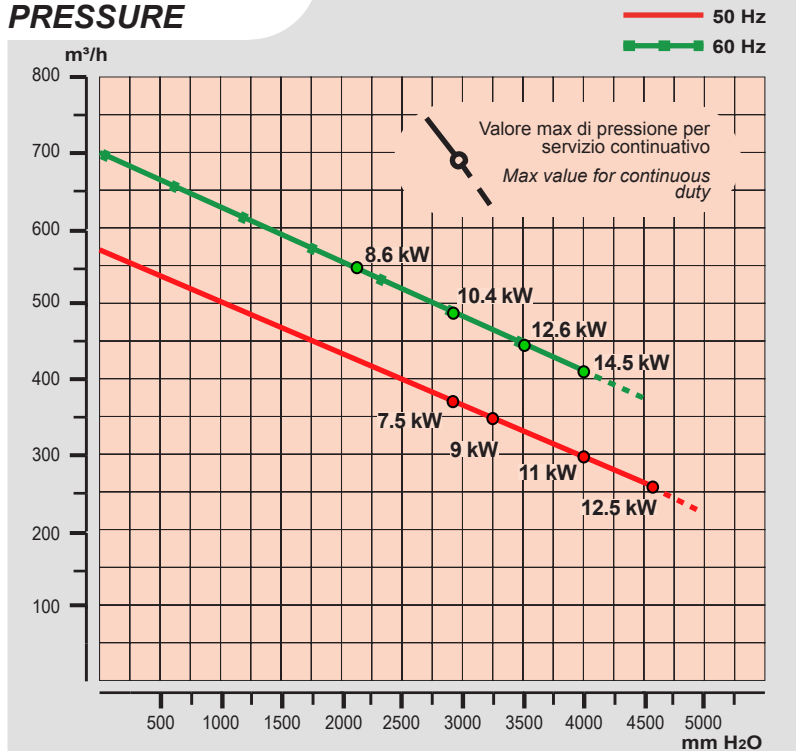

ASSORBIMENTO MOTORE MOTOR ABSORPTION

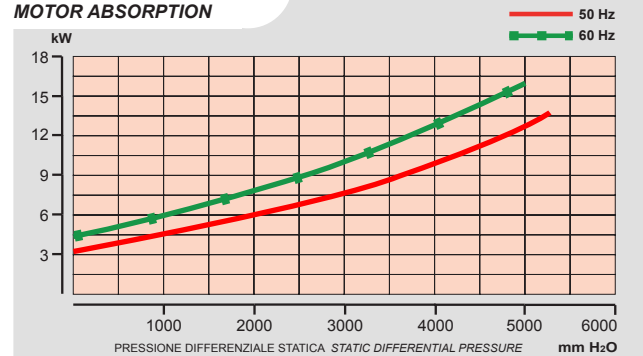

INCREMENTO TEMPERATURA ARIA AIR TEMPERATURE INCREASE

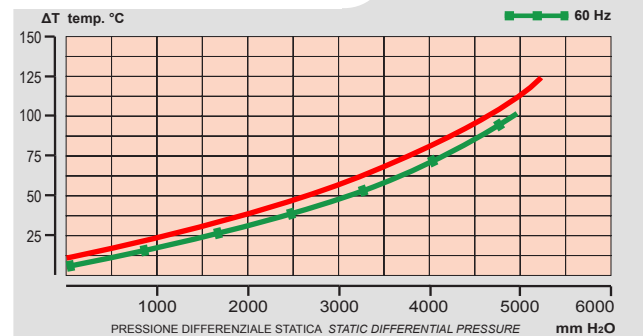

Tutti i dati della presente scheda tecnica si intendono indicativi e potranno essere modificati dalla casa in qualsiasi momento senza nessun preavviso.

La curva di aspirazione è riferita ad aria alla temperatura media di 20 °C e 1013 mbar sul raccordo di mandata.

La curva di compressione è riferita ad aria alla temperatura media di 20 °C e 1013 mbar sul raccordo di aspirazione.

All data is intended as an indication and may be modified without prior notice.

The vacuum curve is valid for pumping air, with a temperature of 20°C at the inlet flange and with a pressure of 1013 mbar at the discharge port.

The pressure curve is valid for pumping air, with an average temperature of 20°C and 1013 mbar at the inlet flange.

l/min = m³/h · 16,667
CFM = m³/h · 0,588
mbar = mm H2O · 0,098
PSI = mm H2O · 0,00142